



verbraucherzentrale

Nordrhein-Westfalen

LI MALÊ ENERJIYÊ SEXBÊR BIKE

Jiyaneke erzan, baş û bitenduristî

Navenda Pêşniyarê ya Serfkaran NRW

Navenda Pêşniyarê ya Serfkaran NRW di gelek qadên jiyânê de alîkariyê dide mirovan, bo nimûne ji bo mijarên wek kontratên telefona berîkê, deyn, fatûre û firoşkarên enerjîyê. Navenda Pêşniyarê ya Serfkaran li 61 bajarên Rhine-Westphaliaha Bakur xwedî navenda pêşniyarê ya serfkaran e. Em dikarin li wan deran alîkariya we bikin. Navenda Pêşniyarê ya Serfkaran NRW serbixwe ye. Ji sedî 90 î zêdetir gelê Rhine-Westphaliaya Bakur baweriya xwe bi Navenda Pêşniyarê ya Serfkaran NRWê tîne, ji ber ku ew alîkariyê didin gelek mirovan. Li ser înternetê hûn dikarin agahiyan û navnîşanên dezgehên pêşniyarê peyde bikin:

www.verbraucherzentrale.nrw

Emê pêşniyarê li we bikin bê ka hûnê çawa bikarin enerjîyê sexbêr bikin.

Ji bo mirovên ku pereyên wan tune pêşniyarkirin bêpere ye:

☎ **0211 - 33 996 555** | **energieberatung@verbraucherzentrale.nrw**

Enerjî gelek pere digire!

Germkirin, ava kel û elektrîk li Almanyayê gelek buha ye. Eger ji we re zêde elektrîk pêwîst neke, hûnê gelek pere berhev bikin û hawirdorê biparêzin. Di vê broşurê de hûnê bibînin ka ev yek çawa dê pêk were.

Li avahiyeke (65 m²) ku 3 mirov tê de dijîn buhayê germkirin, ava kel û elektrîkê yê yek salê ewqas digire.

Elektrîk

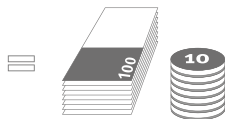

870 €

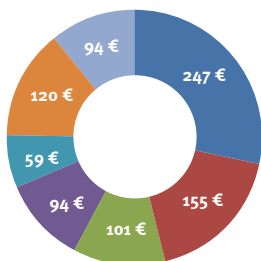

- TV, kompîtir hwd.
- aşpêjî/qerisandin
- kelkirin
- ronahî
- amanşûştin
- makîneya çilşûştinê/zuhakirinê,
- yên din

Germkirin

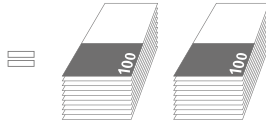

715 € (bi mazot an jî gazê)
2000 € (bi elektrîkê, binêrin rûpel 3)

Ava germ

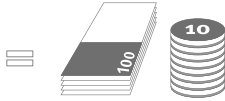

120 € (bi mazot an jî gazê)
580 € (bi elektrîkê, binêrin rûpel 9)

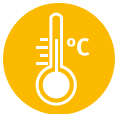

Kengê divê hûn germ bikin?

Li Almanyayê piraniya mirovan xwe rehet hîs dikin eger ku germa li malê navbera 13 û 22 dereceyan be. Dema ku li derwe sar be hîngê em pêwîstî bi germkirinê dibînin °C. Em wek edetî navbera Cotmeh û Avrêlê malê germ dikin.

Germa li derwe (averaj roj/şev)

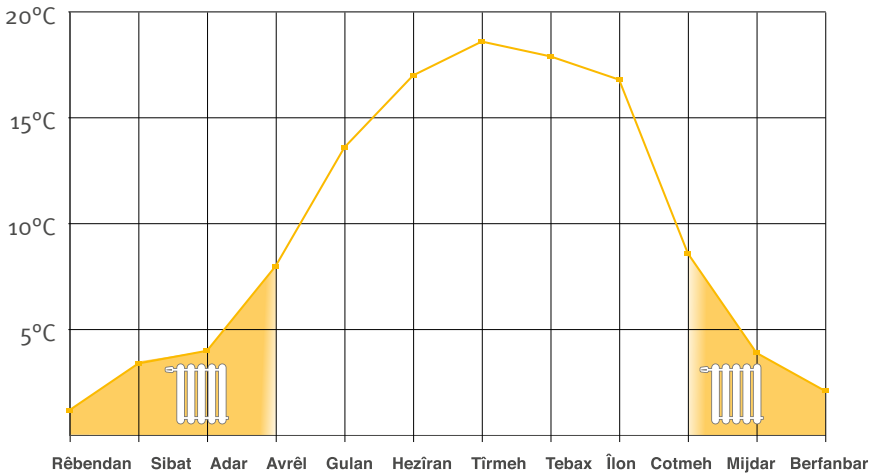



Germkirina bi rêkûpêk wiha ye

Li her malê amraza germkirinê heye. Li ser germkerê (termostat) bişkovke-ke kontrolê heye. Bişkovkê ber bi rastê bizivîrinin. Hûn bi tenê bi germkerê dikarin malê germ bikin.

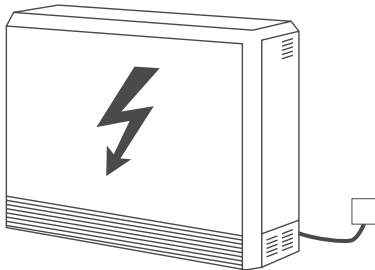
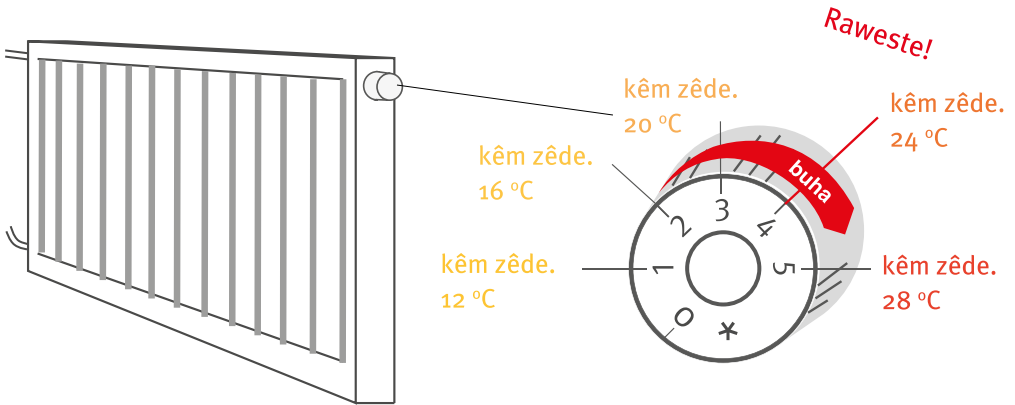

Germkirin buha ye. Germkerên ku bi elektrîkê bixebitin bi taybetî gelek buha ne. Ew germker xwedî kabloyeke hêzê ne. Eger amraza we ya germkirinê bi vî şiklî be derbarê wê pêşniyarê wergirin.



Germkirina bi sexbêrî

Eger germker rast hatibe eyarkirin hûn sexbêriyê dikin.
Germker çiqas germ be, fatûreya we jî dê ewqas zêde be.
Hişyarî: Eger mal pir sar be, hundir ê kufikî be. Pêşniyara me ew e:



Odeyên razanê: Pileya 2-3, 16-18°C



Mitbax: Pileya 2-3, 18°C



Odeya serşûştinê (eger hûn li odeyê bin): Pileya: 3-4, 21-24°C



**Odeya rûniştinê, odeyên razanê yên zarokan,
odeyên xebatê: Pileya 3-4, 20-21°C**

Dema kes li malê tune be pileya germkerê daxînin zyê. Bi vî awayî hûnê sexbêriya pereyê bikin. Zivistanê germkirinê bi pileya 0 eyar nekin!

Mobilyeyan li nêzikî amraza germkirinê bi cih nekin, û divê perde li pêş amraza germkirinê nesekine.

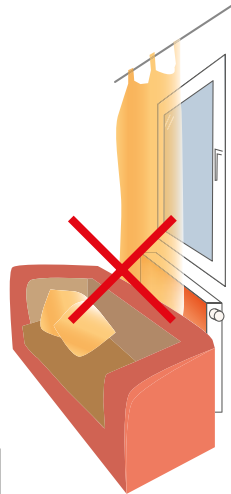
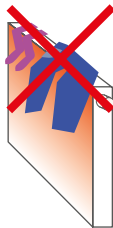

Cilûbergan nedanin li ser germkerê.

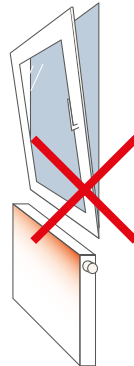

Dema hûn paceyê vedikin amraza germkirinê bigirin.



Dirust hewadar bikin

Serşûştin, aşpêjî, zuhakirina cilûbergan û jiyîn hewayê bixumam dike. Ev xumam divê ji malê bê dûrxistin. Xumam ê bibe sebebê kufikê. Divê hûn hundir hewadar bikin. Ev yek zivistanê pir girîng e!

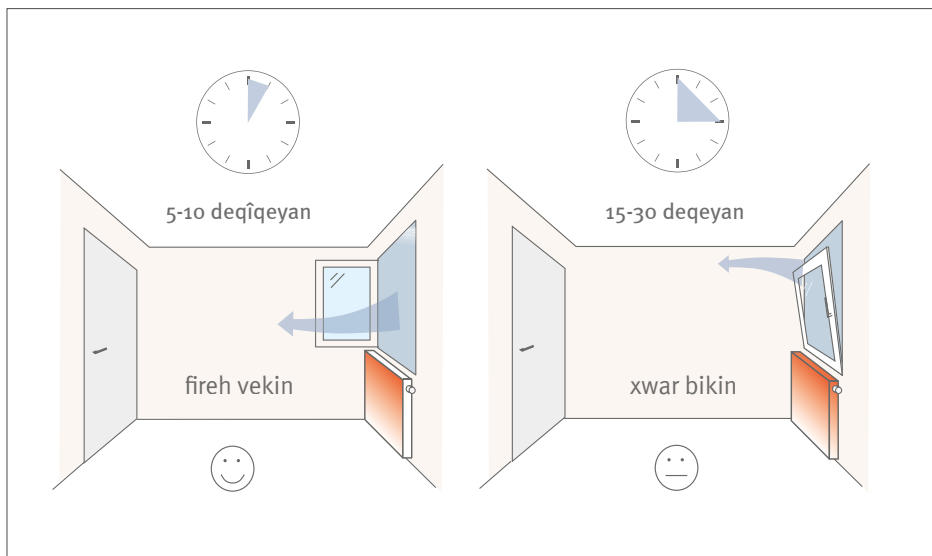
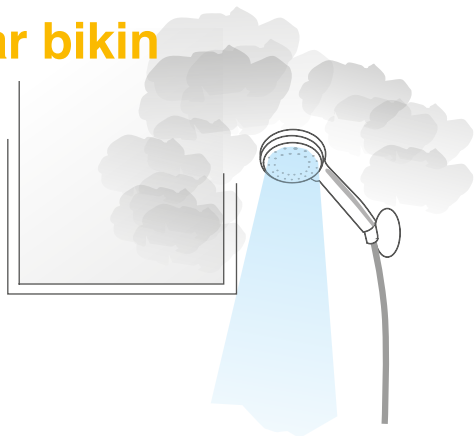

Rojê kêmtirîn sê caran paceyê bi timamî vekin. Paceyê divê bi qasî 5-10 deqîqeyan vekirî bimîne.

Eger hûn paceyê xwar bikin, divê hûn 15-30 deqeyan hundir hewadar bikin.

Piştî aşpêjîyê, serşûştin an jî dûşê zûka hundir hewadar bikin.

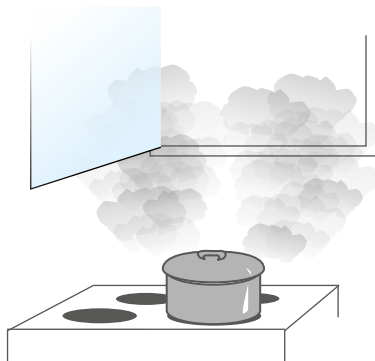

Eger hûn cilûbergan li malê zuha dikin, pêwîst e ku hûn zêdetir hewadariyê bikin. Eger hûn bi têrê hewadar nekin, kufik ê zêde be! Hişyarî: Li gelek malan, zuhagirina cilûbergan a li hundir qedexe ye.

Kufik çî ye?

Kufik bi rêya rutubetê dikeve hundir û deqên qirêj çêdike. Kufik mirov nexweş dixê. Kufik piranî li qulçên malê û pişt mobîlyeyan çêdibe. Eger hûn rastî zêde kufikê bîn, xudanê malê agahdar bikin.

Şîreta me: Werin navenda serfkarê. Em dikarin pêşniyarê li we bikin!





Şûştin û zuhakirin

Dema hûn şûştinê û zuhakirinê dikin, hûn dikarin sexbêriya pereyê bikin:

Baş pê beled bin ku makîneya cilşûştinê tijî ye. Wê çaxê hûnê sexbêriya elektrîkê û pereyê bikin.

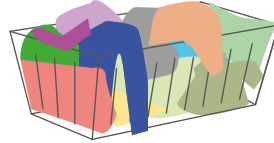

Hindî ku hûn bi ava kel şûştinê bikin ewqas wê buha be. Ji bo şûştineke normal ji we re 30 derece pêwîst e.

Eger hûnê cilûbergên xwe di zuhakerê de hişk bikin, divê hûn destpêkê dewrê bidin cilûbergan. Wê eyar bikin li ser 1.400 dewrê.

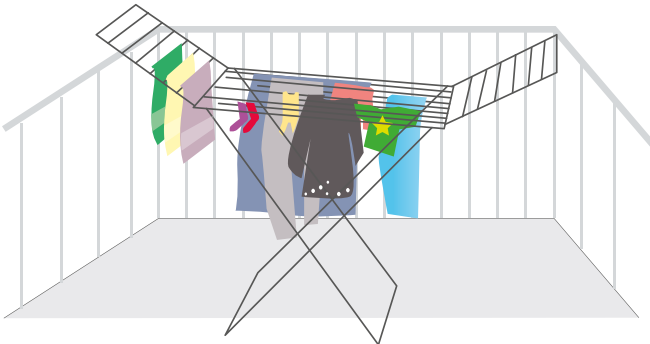
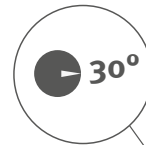

Ya baştirîn ew e ku hûn cilbûrgan li kîlerê, li odeya banîşeyê, an jî li şaneşin an nav bexçe zuha bikin.



Sarkirin û Qerisandin

Eger sarinc and dolaba qerisandinê pir sar be, gelek pere dê ji we biçe:

- Sarinc divê 7 Santîgrat derece be (pileya 2 an jî 3).
- Dolaba qerisandinê divê kêmek 18 derece be.
- Hûn dikarin germiyê bi termometrê bipîvin.

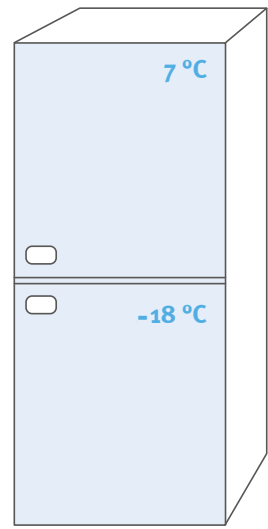
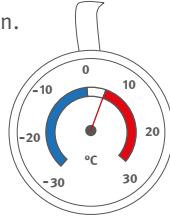

Aşpêjî û nançêkirin

Dema karê aşpêjî û nançêkirinê dikin sexbêriya pereyê bikin:

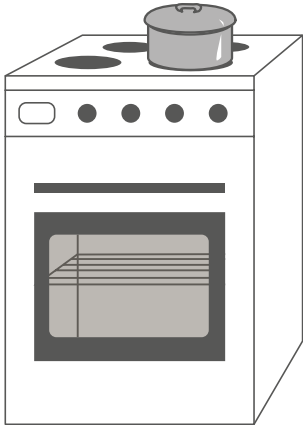

- Qapaxê deynin ser qoşqane û taweyan.
- Dema ku hûn sebze, rişte, kartol an jî birinc dikelînin binê ocaxê kêmk bikin.
- Ji bo çay û qehwê termosê bi kar bînin. Avê bi ketilê bikelînin.
- Ew zûtir dikelînin û kêmtir elektrîk bi kar tînin.
- Dibe ku hûn bi firinê nekarin germ bikin.

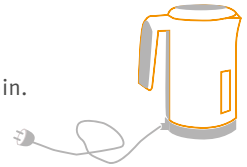



Ava germ

Ava sar erzan e - ava germ buha ye.

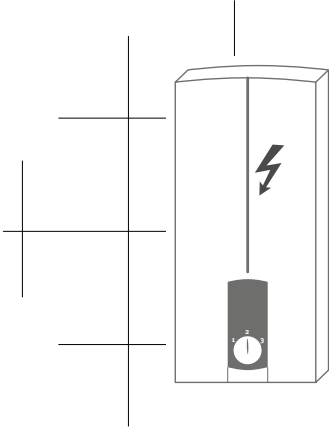

Hişyarî: Li gelek malan ava germ ji amraza kelkirinê tê. Amraza kelkirinê dişibê vê û bi elektrîkê dixebite. Elektrîk pir buha ye! Herin û pêşniyaran wergirin!



Şûştina firaqan

- Wan nav lavaboyê bişon. Ava germ buha ye. Dî nav lavaboyê de ji we re zêde av pêwîst nake. Hûnê sexbêriya pereyê bikin!

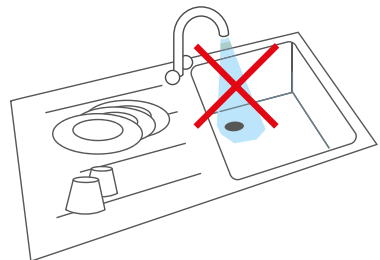
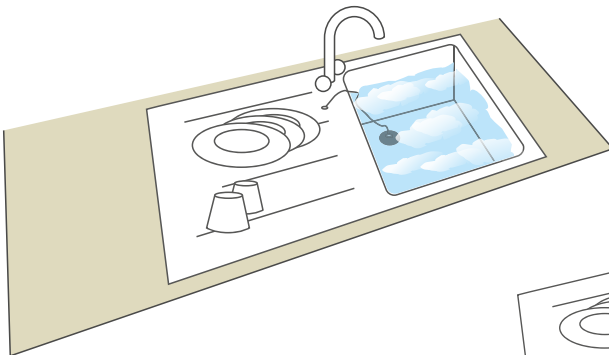



Dûşwergirtin

- Bi tenê ji bo 5 deqeyan bin dûşê bimînin.
- Dûşên kurt erzan in, lê serşûştin buha ye.
- Dema hûn tiraş dibin an jî didanên xwe dişon divê av neherike.

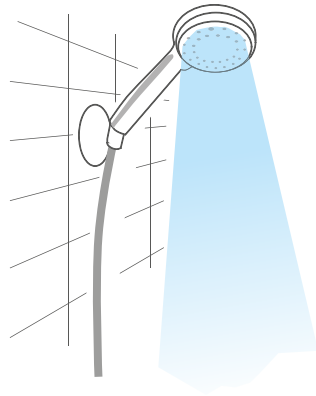

5 deqeyan



Ronahî, kompîtir û TV

Ronahî elektrîkê bi kar tînin. Elektrîk pir buha ye.

Dem a hûn ji odayê derdikevin ronahiyê bitemirînin.

Eger ronahî nexebite lempyên LED ên erzan bikin.

Amrazan bi timamî bigirin. Eger ronahiyek vekirî be, amraz herka hêzê pêwîst dibîne ("stand-by").

Fîşê jê bikişînin an jî fîşeke bi bişkovk bikin.

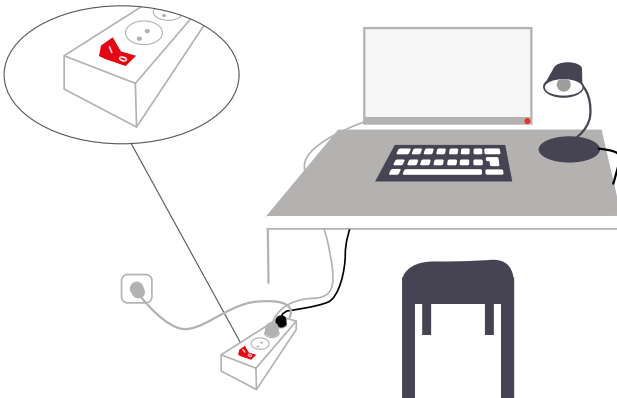

Amrazên ekonomîk bikirîn

Bala xwe bidin serfikirina enerjyê dema ku hûn amrazeke nû ya elektrîkî dikirin. Ev xêzkirina rengîn ê ji we re bibe alîkar: Keskê tarî pir ekonomîk e.

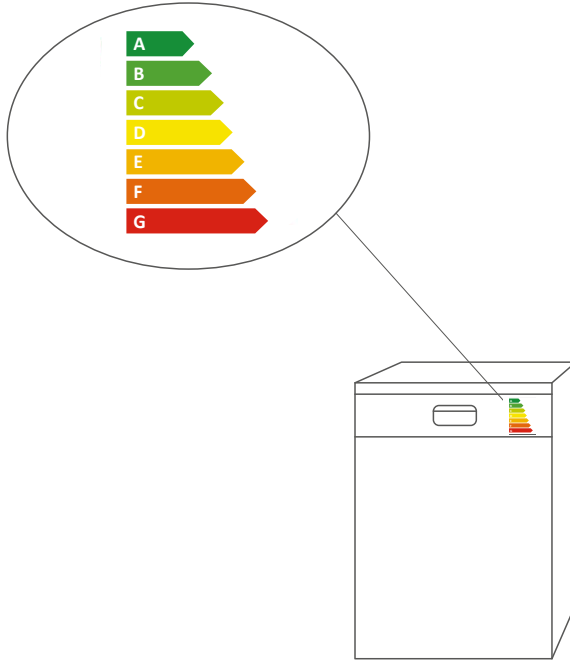

HERAUSGEBER

Verbraucherzentrale NRW

Mintropstr. 27

40215 Düsseldorf

www.energie2020plus.nrw

[f/vznrw.energie](https://www.facebook.com/vznrw.energie)

[t/vznrw_energie](https://www.twitter.com/vznrw_energie)

[i/myhomeisourfuture](https://www.instagram.com/myhomeisourfuture)

02/2022. Bilder: © Fotolia.com: magneticmc; © electricye - stock.adobe.com; © 2013 Zlatan Durakovic
Gestaltung: Verbraucherzentrale NRW, Lea Neck
Anzahl Seiten: 13, 14, 15, 16, 17, 18, 19, 20, 21, 22, 23, 24, 25, 26, 27, 28, 29, 30, 31, 32, 33, 34, 35, 36, 37, 38, 39, 40, 41, 42, 43, 44, 45, 46, 47, 48, 49, 50, 51, 52, 53, 54, 55, 56, 57, 58, 59, 60, 61, 62, 63, 64, 65, 66, 67, 68, 69, 70, 71, 72, 73, 74, 75, 76, 77, 78, 79, 80, 81, 82, 83, 84, 85, 86, 87, 88, 89, 90, 91, 92, 93, 94, 95, 96, 97, 98, 99, 100
Gedruckt auf 100% Recyclingpapier

Das **PROJEKT ENERGIE2020plus** wird gefördert durch:



EUROPÄISCHE UNION
Investition in unsere Zukunft
Europäischer Fonds
für regionale Entwicklung

Ministerium für Umwelt, Landwirtschaft,
Natur- und Verbraucherschutz
des Landes Nordrhein-Westfalen

